

Product Highlights:

- Smaller size and lightweight
- Power range:
400W/500W/800W/1000W
- Beam angles: UNB, NB, MB, UWB
and asymmetric
- Ultra-high efficiency, Choices of
CRI 70, CRI 80
- IP66/IK08

Light is intense

PURSOS® SHP V3 Flood Light (General Edition)

A cost-effective high-performance solution for area lighting applications.

Light is **OSRAM**

Our Brands

traxon e:cue

OSRAM

PURSOS® SHP V3 Flood Light (General Edition)



PURSOS® SHP V3 Flood Light General Edition is a cost-effective high-performance solution for area lighting, such as sports parks, road cross area, harbor and apron, etc. A well-designed forged pure aluminum heatsink offers a better heat dissipation efficiency. The integrated electrical gear box design makes the weight lighter and the size more compact without comprising on the efficiency with up to 9 types of light distribution. PURSOS® SHP V3 Flood Light general edition is the best alternative to the traditional 400W, 600W, 1000W metal halide and halogen flood lights.

Features and Benefits

Compact size, high cost performance

- Smaller size and lightweight
- Ultra-high efficiency, Choices of CRI 70, CRI 80
- Nearly flicker free
- Visors for glare control
- Variety lighting distribution, flexible choice

High reliability

- Lumen maintenance L70-80000 hours @Ta30°C
- Robust aluminum body
- High protection level IP66 & IK08
- Independent surge protector

Applications

- Sport entertainment venues (Sport park, school stadium)
- Training field (Basketball, football, hockey, tennis)
- Street lighting (High mast lighting, cross lighting)
- Harbor / Apron lighting
- Multi-purpose area (MUGA)

Photometrics

UNB

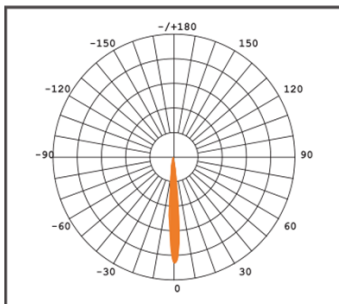

NB

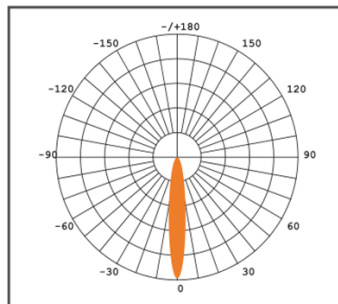

MB

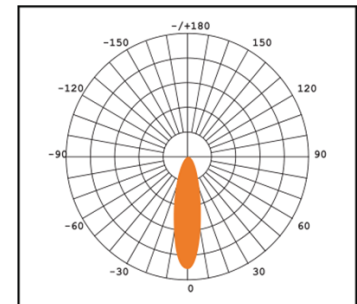

UWB

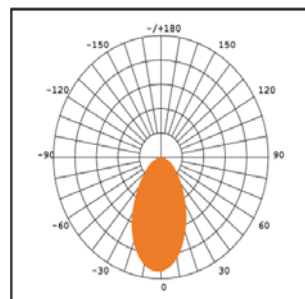

ASY

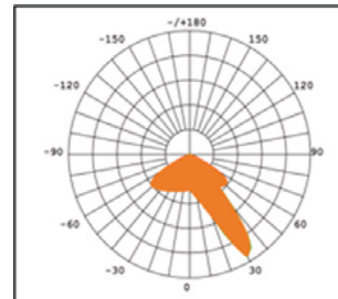

PURSOS® SHP V3 Flood Light (General Edition)

Forging heatsink
Super heat conduction with light weight and small size

Friendly handle design
Easy for transport and installation

Built-in gear box
Integrated / compact

Polycarbonate lens
High transmittance and accurate optical distribution

Adjusting dial
Convenient for lighting adjustment

Strengthened bracket
Powder coating steel bracket and easy for installation

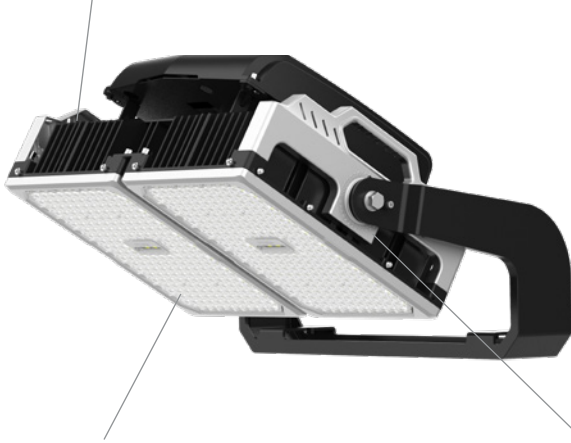

PURSOS® SHP V3 Flood Light (General Edition)

Dimensions



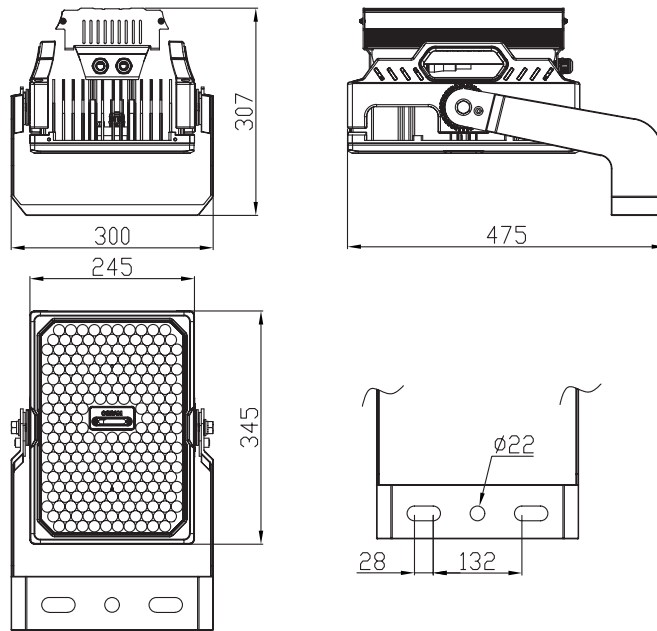

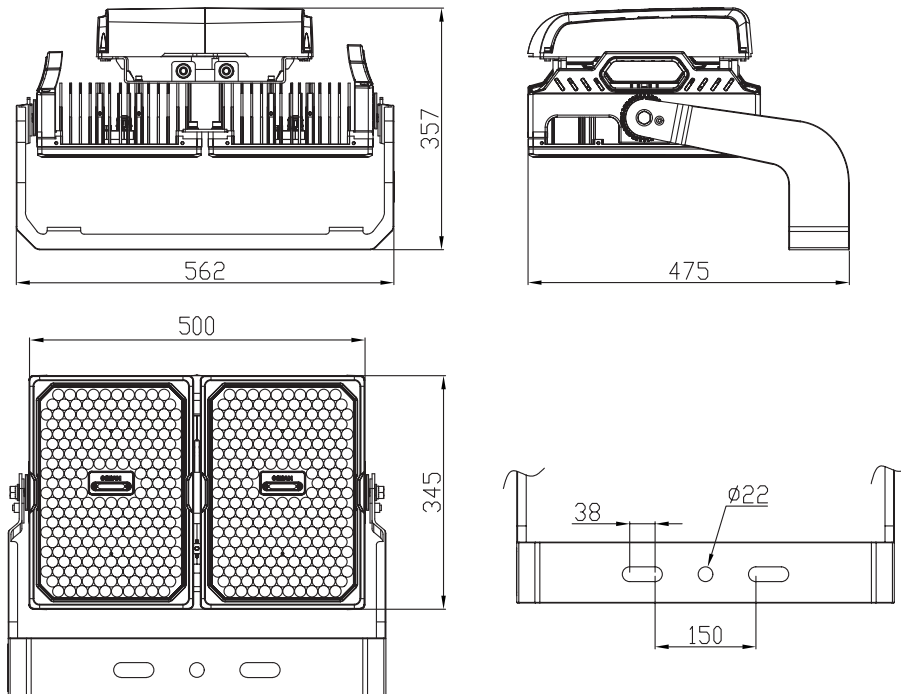

400W / 500W (Unit: mm)



800W / 1000W (Unit: mm)



PURSOS® SHP V3 Flood Light (General Edition)

Product Reference	Ordering Code (EAN40)		V	Hz	W	K					
PSS SHP V3 G 400W 757 UNB VS1 OSRAM	4062172240147	Cold white	220-240	50/60	400	5700	9	475	300	307	1
PSS SHP V3 G 400W 757 NB VS1 OSRAM	4062172240154	Cold white	220-240	50/60	400	5700	15	475	300	307	1
PSS SHP V3 G 400W 757 MB VS1 OSRAM	4062172240161	Cold white	220-240	50/60	400	5700	30	475	300	307	1
PSS SHP V3 G 400W 757 UWB VS1 OSRAM	4062172240178	Cold white	220-240	50/60	400	5700	60	475	300	307	1
PSS SHP V3 G 400W 757 ASY VS1 OSRAM	4062172240185	Cold white	220-240	50/60	400	5700	ASY	475	300	307	1
PSS SHP V3 G 400W 857 UNB VS1 OSRAM	4062172240192	Cold white	220-240	50/60	400	5700	9	475	300	307	1
PSS SHP V3 G 400W 857 NB VS1 OSRAM	4062172240208	Cold white	220-240	50/60	400	5700	15	475	300	307	1
PSS SHP V3 G 400W 857 MB VS1 OSRAM	4062172240215	Cold white	220-240	50/60	400	5700	30	475	300	307	1
PSS SHP V3 G 400W 857 UWB VS1 OSRAM	4062172240222	Cold white	220-240	50/60	400	5700	60	475	300	307	1
PSS SHP V3 G 400W 857 ASY VS1 OSRAM	4062172240239	Cold white	220-240	50/60	400	5700	ASY	475	300	307	1
PSS SHP V3 G 500W 757 UNB VS1 OSRAM	4062172240246	Cold white	220-240	50/60	500	5700	9	475	300	307	1
PSS SHP V3 G 500W 757 NB VS1 OSRAM	4062172240253	Cold white	220-240	50/60	500	5700	15	475	300	307	1
PSS SHP V3 G 500W 757 MB VS1 OSRAM	4062172240260	Cold white	220-240	50/60	500	5700	30	475	300	307	1
PSS SHP V3 G 500W 757 UWB VS1 OSRAM	4062172240277	Cold white	220-240	50/60	500	5700	60	475	300	307	1
PSS SHP V3 G 500W 757 ASY VS1 OSRAM	4062172240284	Cold white	220-240	50/60	500	5700	ASY	475	300	307	1
PSS SHP V3 G 500W 857 UNB VS1 OSRAM	4062172240291	Cold white	220-240	50/60	500	5700	9	475	300	307	1
PSS SHP V3 G 500W 857 NB VS1 OSRAM	4062172240307	Cold white	220-240	50/60	500	5700	15	475	300	307	1
PSS SHP V3 G 500W 857 MB VS1 OSRAM	4062172240314	Cold white	220-240	50/60	500	5700	30	475	300	307	1
PSS SHP V3 G 500W 857 UWB VS1 OSRAM	4062172240321	Cold white	220-240	50/60	500	5700	60	475	300	307	1
PSS SHP V3 G 500W 857 ASY VS1 OSRAM	4062172240338	Cold white	220-240	50/60	500	5700	ASY	475	300	307	1
PSS SHP V3 G 800W 757 UNB VS1 OSRAM	4062172240345	Cold white	220-240	50/60	800	5700	9	475	562	357	1
PSS SHP V3 G 800W 757 NB VS1 OSRAM	4062172240352	Cold white	220-240	50/60	800	5700	15	475	562	357	1
PSS SHP V3 G 800W 757 MB VS1 OSRAM	4062172240369	Cold white	220-240	50/60	800	5700	30	475	562	357	1
PSS SHP V3 G 800W 757 UWB VS1 OSRAM	4062172240376	Cold white	220-240	50/60	800	5700	60	475	562	357	1
PSS SHP V3 G 800W 757 ASY VS1 OSRAM	4062172240383	Cold white	220-240	50/60	800	5700	ASY	475	562	357	1
PSS SHP V3 G 800W 857 UNB VS1 OSRAM	4062172240390	Cold white	220-240	50/60	800	5700	9	475	562	357	1
PSS SHP V3 G 800W 857 NB VS1 OSRAM	4062172240406	Cold white	220-240	50/60	800	5700	15	475	562	357	1
PSS SHP V3 G 800W 857 MB VS1 OSRAM	4062172240413	Cold white	220-240	50/60	800	5700	30	475	562	357	1
PSS SHP V3 G 800W 857 UWB VS1 OSRAM	4062172240420	Cold white	220-240	50/60	800	5700	60	475	562	357	1
PSS SHP V3 G 800W 857 ASY VS1 OSRAM	4062172240437	Cold white	220-240	50/60	800	5700	ASY	475	562	357	1
PSS SHP V3 G 1000W 757 UNB VS1 OSRAM	4062172240444	Cold white	220-240	50/60	1000	5700	9	475	562	357	1
PSS SHP V3 G 1000W 757 NB VS1 OSRAM	4062172240451	Cold white	220-240	50/60	1000	5700	15	475	562	357	1
PSS SHP V3 G 1000W 757 MB VS1 OSRAM	4062172240468	Cold white	220-240	50/60	1000	5700	30	475	562	357	1
PSS SHP V3 G 1000W 757 UWB VS1 OSRAM	4062172240475	Cold white	220-240	50/60	1000	5700	60	475	562	357	1
PSS SHP V3 G 1000W 757 ASY VS1 OSRAM	4062172240482	Cold white	220-240	50/60	1000	5700	ASY	475	562	357	1
PSS SHP V3 G 1000W 857 UNB VS1 OSRAM	4062172240499	Cold white	220-240	50/60	1000	5700	9	475	562	357	1
PSS SHP V3 G 1000W 857 NB VS1 OSRAM	4062172240505	Cold white	220-240	50/60	1000	5700	15	475	562	357	1
PSS SHP V3 G 1000W 857 MB VS1 OSRAM	4062172240512	Cold white	220-240	50/60	1000	5700	30	475	562	357	1
PSS SHP V3 G 1000W 857 UWB VS1 OSRAM	4062172240529	Cold white	220-240	50/60	1000	5700	60	475	562	357	1
PSS SHP V3 G 1000W 857 ASY VS1 OSRAM	4062172240536	Cold white	220-240	50/60	1000	5700	ASY	475	562	357	1
Accessories											
PSS SHP V3 VISOR 1000W ACC VS4 OSRAM	4062172242035										

Technical data subject to variation and change without notice.

Traxon e:cue

Sales enquiry: Traxon.ecue.newsletter@osram.com

www.osram.asia/ls





Product Highlights:

- DMX-RDM interface, DALI and 0-10V dimming
- Support HDTV broadcasting standard
- Power range: 800W/1000W/1200W/1500W
- Beam angles: UNB, NB, MB, UWB and asymmetric
- Flicker free
- IP66/IK08

Light is intense

PURSOS® SHP V3 Flood Light (Premium Edition)

An innovative flood lighting solution for big area applications.

Light is **OSRAM**

Our Brands

traxon e:cue

OSRAM

PURSOS® SHP V3 Flood Light (Premium Edition)

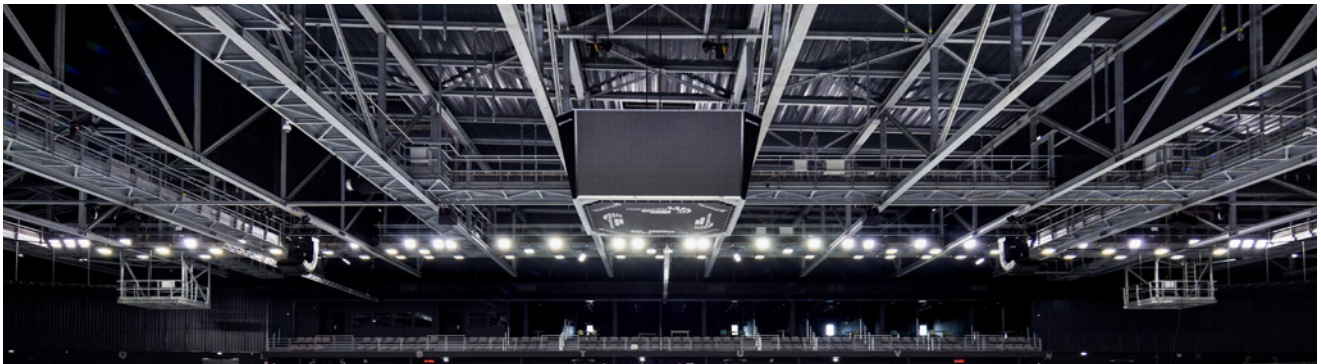

PURSOS® SHP V3 Flood Light Premium Edition is an innovative stadium lighting solution supporting the latest TV broadcasting standards. A well-designed forged pure aluminum heatsink offers a better heat dissipation efficiency but remaining a high light efficiency with up to 9 types of light distribution. The flexible electrical gear box design can be separately fixed in the appropriate position or be integrated into the bracket. It also provides DMX / RDM control interface and DALI and 0-10V dimming. It can achieve an intelligent lighting control with our e:cue control management system, such as the right illumination by scheduling and customized lighting shows. PURSOS® SHP V3 premium edition is the best choice for renovation/new stadiums and multi-purpose area lighting projects, it not only produces a good lighting effect, but also greatly reduce the investment and maintenance costs.

Features and Benefits

Support HDTV broadcasting standard

- Flicker free & choices of CRI 70, CRI 80, CRI 90
- Variety lighting distributions
- Additional visors for better glare control
- Compact size and light weight
- Special effects and light shows

High reliability

- Lumen maintenance L80-50000 hours @Ta30°C
- Robust aluminum body
- High protection level IP66 & IK08
- Independent surge protector

Intelligent control

- DMX-RDM interface, DALI and 0-10V dimming
- Provide lighting control with e:cue lighting management system

Applications

- Indoor arenas (Basketball court, Ice hockey)
- Outdoor arenas (Stadium, Football pitch, Tennis, Golf course, Hockey field)
- Multi-purpose area (MUGA)

Photometrics

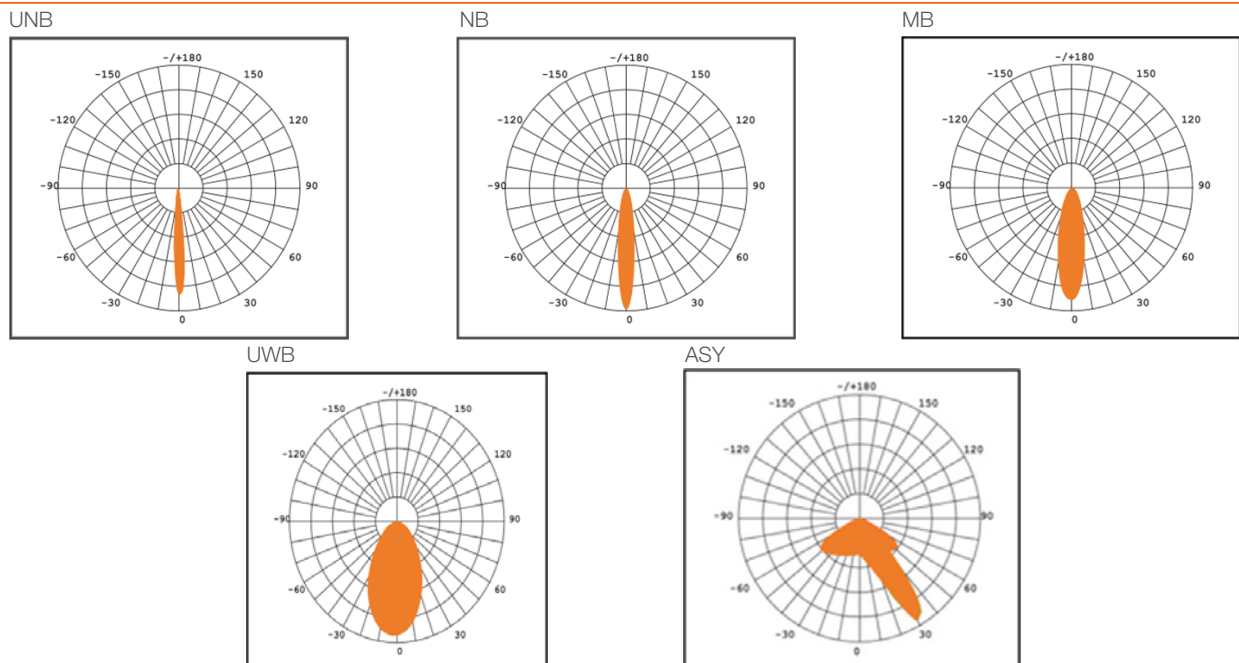

PURSOS® SHP V3 Flood Light (Premium Edition)

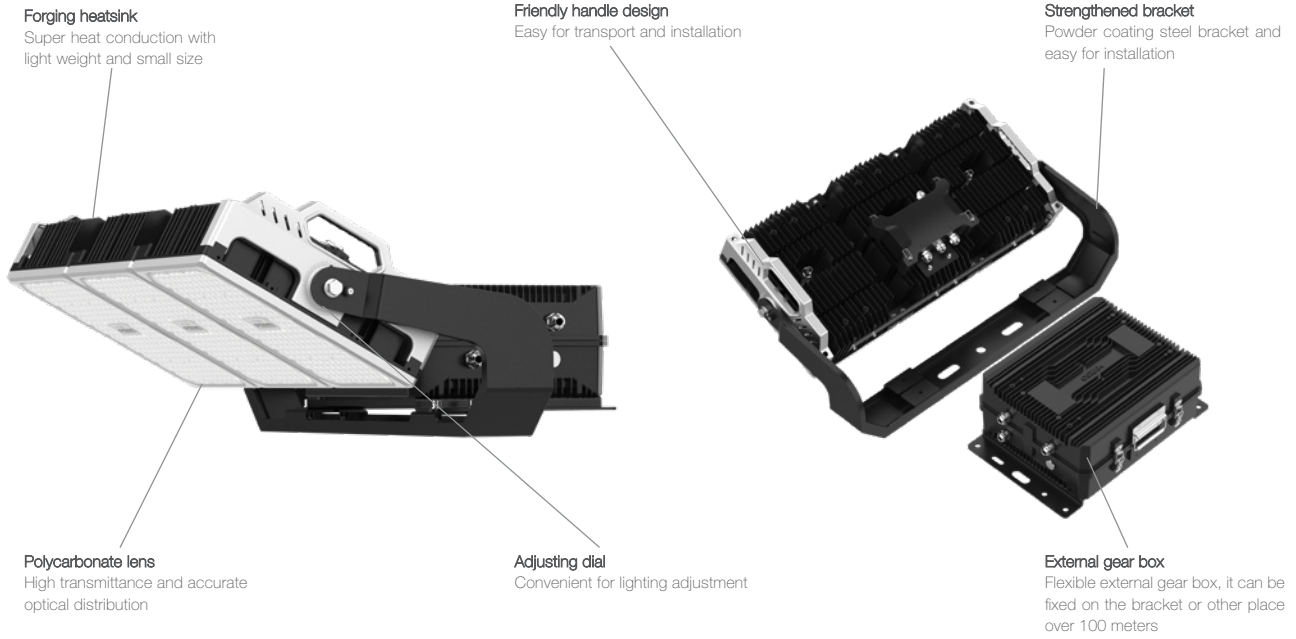

Dimensions

800W / 1000W (Unit: mm)

Light Engine

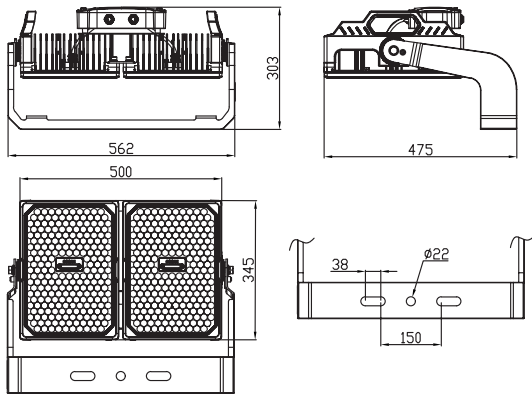

Gear box

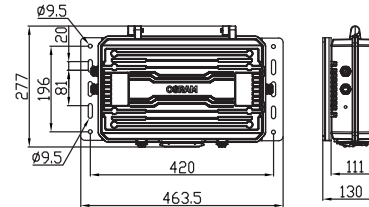

1200W / 1500W (Unit: mm)

Light Engine

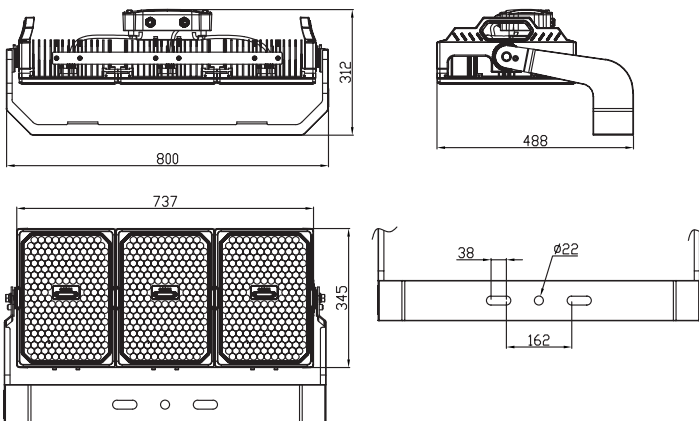



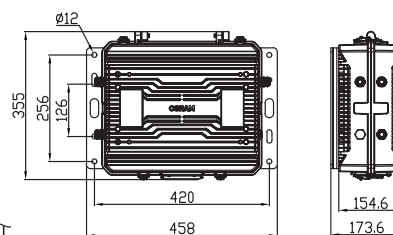







Gear box







PURSOS® SHP V3 Flood Light (Premium Edition)



Product Reference	Ordering Code (EAN40)										
Light Engine											
PSS SHP V3 P 800W 757 UNB VS1 OSRAM	4062172240543	Cold white	N/A	N/A	800	5700	9	475	562	303	1
PSS SHP V3 P 800W 757 NB VS1 OSRAM	4062172240550	Cold white	N/A	N/A	800	5700	15	475	562	303	1
PSS SHP V3 P 800W 757 MB VS1 OSRAM	4062172240567	Cold white	N/A	N/A	800	5700	30	475	562	303	1
PSS SHP V3 P 800W 757 UWB VS1 OSRAM	4062172240574	Cold white	N/A	N/A	800	5700	60	475	562	303	1
PSS SHP V3 P 800W 757 ASY VS1 OSRAM	4062172240581	Cold white	N/A	N/A	800	5700	ASY	475	562	303	1
PSS SHP V3 P 800W 857 UNB VS1 OSRAM	4062172240598	Cold white	N/A	N/A	800	5700	9	475	562	303	1
PSS SHP V3 P 800W 857 NB VS1 OSRAM	4062172240604	Cold white	N/A	N/A	800	5700	15	475	562	303	1
PSS SHP V3 P 800W 857 MB VS1 OSRAM	4062172240611	Cold white	N/A	N/A	800	5700	30	475	562	303	1
PSS SHP V3 P 800W 857 UWB VS1 OSRAM	4062172240628	Cold white	N/A	N/A	800	5700	60	475	562	303	1
PSS SHP V3 P 800W 857 ASY VS1 OSRAM	4062172240635	Cold white	N/A	N/A	800	5700	ASY	475	562	303	1
PSS SHP V3 P 800W 957 UNB VS1 OSRAM	4062172244251	Cold white	N/A	N/A	800	5700	9	475	562	303	1
PSS SHP V3 P 800W 957 NB VS1 OSRAM	4062172244268	Cold white	N/A	N/A	800	5700	15	475	562	303	1
PSS SHP V3 P 800W 957 MB VS1 OSRAM	4062172244275	Cold white	N/A	N/A	800	5700	30	475	562	303	1
PSS SHP V3 P 800W 957 UWB VS1 OSRAM	4062172244282	Cold white	N/A	N/A	800	5700	60	475	562	303	1
PSS SHP V3 P 800W 957 ASY VS1 OSRAM	4062172244299	Cold white	N/A	N/A	800	5700	ASY	475	562	303	1
PSS SHP V3 P 1000W 757 UNB VS1 OSRAM	4062172240642	Cold white	N/A	N/A	1000	5700	9	475	562	303	1
PSS SHP V3 P 1000W 757 NB VS1 OSRAM	4062172240659	Cold white	N/A	N/A	1000	5700	15	475	562	303	1
PSS SHP V3 P 1000W 757 MB VS1 OSRAM	4062172240666	Cold white	N/A	N/A	1000	5700	30	475	562	303	1
PSS SHP V3 P 1000W 757 UWB VS1 OSRAM	4062172240673	Cold white	N/A	N/A	1000	5700	60	475	562	303	1
PSS SHP V3 P 1000W 757 ASY VS1 OSRAM	4062172240680	Cold white	N/A	N/A	1000	5700	ASY	475	562	303	1
PSS SHP V3 P 1000W 857 UNB VS1 OSRAM	4062172240697	Cold white	N/A	N/A	1000	5700	9	477	562	338	1
PSS SHP V3 P 1000W 857 NB VS1 OSRAM	4062172240703	Cold white	N/A	N/A	1000	5700	15	475	562	303	1
PSS SHP V3 P 1000W 857 MB VS1 OSRAM	4062172240710	Cold white	N/A	N/A	1000	5700	30	475	562	303	1
PSS SHP V3 P 1000W 857 UWB VS1 OSRAM	4062172240727	Cold white	N/A	N/A	1000	5700	60	475	562	303	1
PSS SHP V3 P 1000W 857 ASY VS1 OSRAM	4062172240734	Cold white	N/A	N/A	1000	5700	ASY	475	562	303	1
PSS SHP V3 P 1000W 957 UNB VS1 OSRAM	4062172244305	Cold white	N/A	N/A	1000	5700	9	475	562	303	1
PSS SHP V3 P 1000W 957 NB VS1 OSRAM	4062172244312	Cold white	N/A	N/A	1000	5700	15	475	562	303	1
PSS SHP V3 P 1000W 957 MB VS1 OSRAM	4062172244329	Cold white	N/A	N/A	1000	5700	30	475	562	303	1
PSS SHP V3 P 1000W 957 UWB VS1 OSRAM	4062172244336	Cold white	N/A	N/A	1000	5700	60	475	562	303	1
PSS SHP V3 P 1000W 957 ASY VS1 OSRAM	4062172244343	Cold white	N/A	N/A	1000	5700	ASY	475	562	303	1

PURSOS® SHP V3 Flood Light (Premium Edition)

Product Reference	Ordering Code (EAN40)		V	Hz	W	K		I [mm]	W [m]	h [mm]	
PSS SHP V3 P 1200W 757 UNB VS1 OSRAM	4062172240741	Cold white	N/A	N/A	1200	5700	9	488	800	312	1
PSS SHP V3 P 1200W 757 NB VS1 OSRAM	4062172240758	Cold white	N/A	N/A	1200	5700	15	488	800	312	1
PSS SHP V3 P 1200W 757 MB VS1 OSRAM	4062172240765	Cold white	N/A	N/A	1200	5700	30	488	800	312	1
PSS SHP V3 P 1200W 757 UWB VS1 OSRAM	4062172240772	Cold white	N/A	N/A	1200	5700	60	488	800	312	1
PSS SHP V3 P 1200W 757 ASY VS1 OSRAM	4062172240789	Cold white	N/A	N/A	1200	5700	ASY	488	800	312	1
PSS SHP V3 P 1200W 857 UNB VS1 OSRAM	4062172240796	Cold white	N/A	N/A	1200	5700	9	488	800	312	1
PSS SHP V3 P 1200W 857 NB VS1 OSRAM	4062172240802	Cold white	N/A	N/A	1200	5700	15	488	800	312	1
PSS SHP V3 P 1200W 857 MB VS1 OSRAM	4062172240819	Cold white	N/A	N/A	1200	5700	30	488	800	312	1
PSS SHP V3 P 1200W 857 UWB VS1 OSRAM	4062172240826	Cold white	N/A	N/A	1200	5700	60	488	800	312	1
PSS SHP V3 P 1200W 857 ASY VS1 OSRAM	4062172240833	Cold white	N/A	N/A	1200	5700	ASY	488	800	312	1
PSS SHP V3 P 1200W 957 UNB VS1 OSRAM	4062172244350	Cold white	N/A	N/A	1200	5700	9	488	800	312	1
PSS SHP V3 P 1200W 957 NB VS1 OSRAM	4062172244367	Cold white	N/A	N/A	1200	5700	15	488	800	312	1
PSS SHP V3 P 1200W 957 MB VS1 OSRAM	4062172244374	Cold white	N/A	N/A	1200	5700	30	488	800	312	1
PSS SHP V3 P 1200W 957 UWB VS1 OSRAM	4062172244381	Cold white	N/A	N/A	1200	5700	60	488	800	312	1
PSS SHP V3 P 1200W 957 ASY VS1 OSRAM	4062172244398	Cold white	N/A	N/A	1200	5700	ASY	488	800	312	1
PSS SHP V3 P 1500W 757 UNB VS1 OSRAM	4062172240840	Cold white	N/A	N/A	1500	5700	9	488	800	312	1
PSS SHP V3 P 1500W 757 NB VS1 OSRAM	4062172240857	Cold white	N/A	N/A	1500	5700	15	488	800	312	1
PSS SHP V3 P 1500W 757 MB VS1 OSRAM	4062172240864	Cold white	N/A	N/A	1500	5700	30	488	800	312	1
PSS SHP V3 P 1500W 757 UWB VS1 OSRAM	4062172240871	Cold white	N/A	N/A	1500	5700	60	488	800	312	1
PSS SHP V3 P 1500W 757 ASY VS1 OSRAM	4062172240888	Cold white	N/A	N/A	1500	5700	ASY	488	800	312	1
PSS SHP V3 P 1500W 857 UNB VS1 OSRAM	4062172240895	Cold white	N/A	N/A	1500	5700	9	488	800	312	1
PSS SHP V3 P 1500W 857 NB VS1 OSRAM	4062172240901	Cold white	N/A	N/A	1500	5700	15	488	800	312	1
PSS SHP V3 P 1500W 857 MB VS1 OSRAM	4062172240918	Cold white	N/A	N/A	1500	5700	30	488	800	312	1
PSS SHP V3 P 1500W 857 UWB VS1 OSRAM	4062172240925	Cold white	N/A	N/A	1500	5700	60	488	800	312	1
PSS SHP V3 P 1500W 857 ASY VS1 OSRAM	4062172240932	Cold white	N/A	N/A	1500	5700	ASY	488	800	312	1
PSS SHP V3 P 1500W 957 UNB VS1 OSRAM	4062172244404	Cold white	N/A	N/A	1500	5700	9	488	800	312	1
PSS SHP V3 P 1500W 957 NB VS1 OSRAM	4062172244411	Cold white	N/A	N/A	1500	5700	15	488	800	312	1
PSS SHP V3 P 1500W 957 MB VS1 OSRAM	4062172244428	Cold white	N/A	N/A	1500	5700	30	488	800	312	1
PSS SHP V3 P 1500W 957 UWB VS1 OSRAM	4062172244435	Cold white	N/A	N/A	1500	5700	60	488	800	312	1
PSS SHP V3 P 1500W 957 ASY VS1 OSRAM	4062172244442	Cold white	N/A	N/A	1500	5700	ASY	488	800	312	1
Gear Box			V	Hz	W			I [mm]	W [m]	h [mm]	
PSS SHP V3 P 800W GEARBOX DMX VS1 OSRAM	4062172241977	N/A	220-240	50/60	800	DMX		464	277	130	1
PSS SHP V3 P 1000W GEARBOX DMX VS1 OSRAM	4062172241984	N/A	220-240	50/60	100	DMX		464	277	130	1
PSS SHP V3 P 1200W GEARBOX DMX VS1 OSRAM	4062172241991	N/A	220-240	50/60	1200	DMX		458	355	174	1
PSS SHP V3 P 1500W GEARBOX DMX VS1 OSRAM	4062172242004	N/A	220-240	50/60	1500	DMX		458	355	174	1
PSS SHP V3 P 800W GEARBOX DIM VS1 OSRAM	4062172262033	N/A	220-240	50/60	800	0-10V/PWM		464	277	130	1
PSS SHP V3 P 1000W GEARBOX DIM VS1 OSRAM	4062172262040	N/A	220-240	50/60	100	0-10V/PWM		464	277	130	1
PSS SHP V3 P 1200W GEARBOX DIM VS1 OSRAM	4062172262057	N/A	220-240	50/60	1200	0-10V/PWM		458	355	174	1
PSS SHP V3 P 1500W GEARBOX DIM VS1 OSRAM	4062172262064	N/A	220-240	50/60	1500	0-10V/PWM		458	355	174	1
PSS SHP V3 P 800W GEARBOX DALI VS1 OSRAM	4062172261968	N/A	220-240	50/60	800	DALI		464	277	130	1
PSS SHP V3 P 1000W GEARBOX DALI VS1 OSRAM	4062172261975	N/A	220-240	50/60	100	DALI		464	277	130	1
PSS SHP V3 P 1200W GEARBOX DALI VS1 OSRAM	4062172262019	N/A	220-240	50/60	1200	DALI		458	355	174	1
PSS SHP V3 P 1500W GEARBOX DALI VS1 OSRAM	4062172262026	N/A	220-240	50/60	1500	DALI		458	355	174	1
Accessories											
PSS SHP V3 CABLE 2CORE 1METER VS20 OSRAM	4062172242011	N/A									
PSS SHP V3 CABLE 5CORE 1METER VS20 OSRAM	4062172242028	N/A									
PSS SHP V3 VISOR 1000W ACC VS4 OSRAM	4062172242035	N/A									
PSS SHP V3 VISOR 1500W ACC VS4 OSRAM	4062172242042	N/A									

Technical data subject to variation and change without notice.

Traxon e:cue

Sales enquiry: Traxon.ecue.newsletter@osram.com

www.osram.asia/ls



OSRAM copyrights reserved 2021. Subject to change without notice. Errors and omission excepted. All images used are for illustrative purposes only and not intended to reflect actual product performance.